



TEREX | COMEDIL

Gru a torre "Flat Top"

"Flat Top" Tower Crane • Grue à tour "Flat Top"

"Flat Top" Turmdrehkran • Grúa torre "Flat Top"

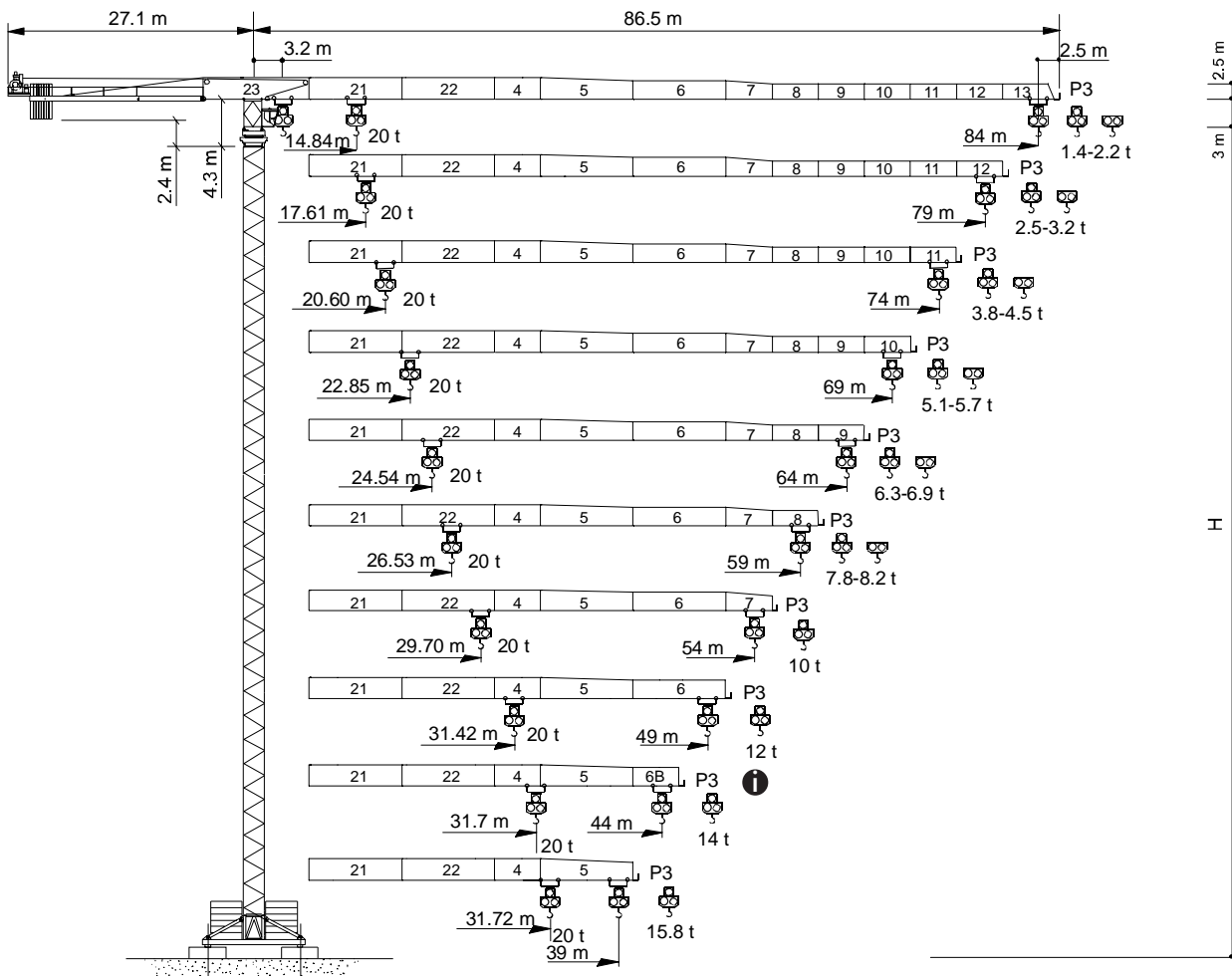

CE FEM 1.001 A3

Dati illustrativi non impegnativi
Con riserva di modifica senza preavviso

Specifications and data not binding
Subject to modification without notice

Données techniques seulement indicatives
Modifications réservées sans préavis

Angaben und Beschreibung unverbindlich
Änderungen vorbehalten ohne weitere Mitteilung

Dibujos y datos sin compromiso
Modificaciones reservadas sin preaviso

UTEDOC.REV.001-4

CTT 561/A-20 HD23

Diagramma di portata (I) **Courbes de charges** (F) **Curvas de cargas** (E)
Load Diagram (GB) **Lastkurven** (D)

		CTT 561/A - 20														
		m	19	24	29	34	39	44	49	54	59	64	69	74	79	84
10 t	- 28,24 m	t	10,00	10,00	9,28	7,64	6,66	5,69	4,93	4,31	3,81	3,38	3,02	2,71	2,44	2,20
10 t	- 26,09 m	t	10,00	10,00	8,29	6,70	5,74	4,80	4,06	3,46	2,96	2,55	2,20	1,89	1,63	1,40
20 t	- 14,84 m	t	13,78	10,37	8,17	6,62	5,68	4,76	4,03	3,44	2,95	2,54	2,19	1,89	1,63	1,40
10 t	- 33,36 m	t	10,00	10,00	10,00	9,43	8,25	7,09	6,18	5,44	4,84	4,33	3,90	3,52	3,20	
10 t	- 31,19 m	t	10,00	10,00	10,00	8,60	7,44	6,31	5,42	4,70	4,10	3,60	3,18	2,82	2,50	
20 t	- 17,61 m	t	17,13	13,02	10,37	8,51	7,37	6,26	5,38	4,67	4,09	3,60	3,18	2,81	2,50	
10 t	- 39,14 m	t	10,00	10,00	10,00	10,00	10,00	8,68	7,61	6,75	6,04	5,44	4,94	4,50		
10 t	- 36,74 m	t	10,00	10,00	10,00	10,00	9,27	7,93	6,87	6,02	5,32	4,73	4,23	3,80		
20 t	- 20,60 m	t	20,00	15,86	12,72	10,52	9,19	7,87	6,84	6,00	5,30	4,72	4,23	3,80		
10 t	- 43,41 m	t	10,00	10,00	10,00	10,00	10,00	9,84	8,66	7,71	6,92	6,26	5,70			
10 t	- 41,13 m	t	10,00	10,00	10,00	10,00	10,00	9,19	8,03	7,08	6,31	5,65	5,10			
20 t	- 22,85 m	t	20,00	18,00	14,52	12,08	10,60	9,14	7,99	7,06	6,29	5,65	5,10			
10 t	- 46,93 m	t	10,00	10,00	10,00	10,00	10,00	10,00	9,50	8,47	7,62	6,90				
10 t	- 44,37 m	t	10,00	10,00	10,00	10,00	10,00	10,00	8,85	7,83	7,00	6,30				
20 t	- 24,54 m	t	20,00	19,57	15,83	13,21	11,62	10,05	8,82	7,82	6,99	6,30				
10 t	- 49,89 m	t	10,00	10,00	10,00	10,00	10,00	10,00	10,00	9,11	8,20					
10 t	- 48,18 m	t	10,00	10,00	10,00	10,00	10,00	10,00	9,80	8,70	7,80					
20 t	- 26,53 m	t	20,00	20,00	17,36	14,53	12,81	11,11	9,77	8,69	7,80					
10 t	- 54,00 m	t	10,00	10,00	10,00	10,00	10,00	10,00	10,00	10,00						
10 t	- 54,00 m	t	10,00	10,00	10,00	10,00	10,00	10,00	10,00	10,00						
20 t	- 29,70 m	t	20,00	20,00	19,77	16,58	14,64	12,73	11,22	10,00						
10 t	- 49,00 m	t	10,00	10,00	10,00	10,00	10,00	10,00	10,00							
10 t	- 49,00 m	t	10,00	10,00	10,00	10,00	10,00	10,00	10,00							
20 t	- 31,42 m	t	20,00	20,00	20,00	17,69	15,63	13,60	12,00							
10 t	- 39,00 m	t	10,00	10,00	10,00	10,00	10,00									
10 t	- 39,00 m	t	10,00	10,00	10,00	10,00	10,00									
20 t	- 31,72 m	t	20,00	20,00	20,00	17,88	15,80									

Altre installazioni (I) **Autres implantations** (F) **Otras implantaciones** (E)
Other configurations (GB) **Aufstellmöglichkeiten** (D)

Gru climbing - Bottom climbing crane - Télescopage sur dalles
Kletterkran im Gebäude - Grúa trepadora

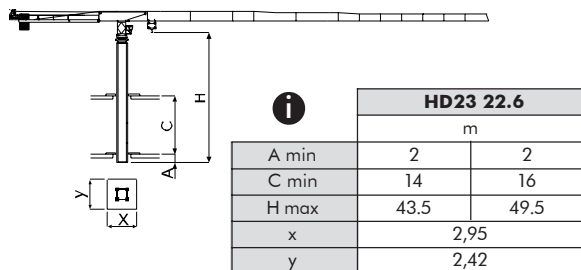

Gru ancorata - Crane tied to the structure - Grue ancrée
Geankerter Kran - Grúa anclada

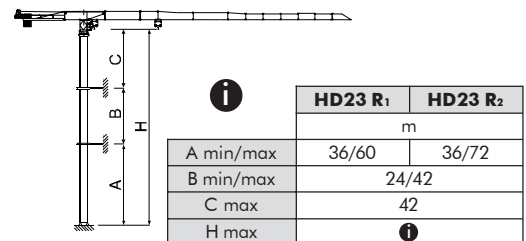

Torre **I**

Tower **GB**

Tour **F**

Turm **D**

Torre **E**

HD23

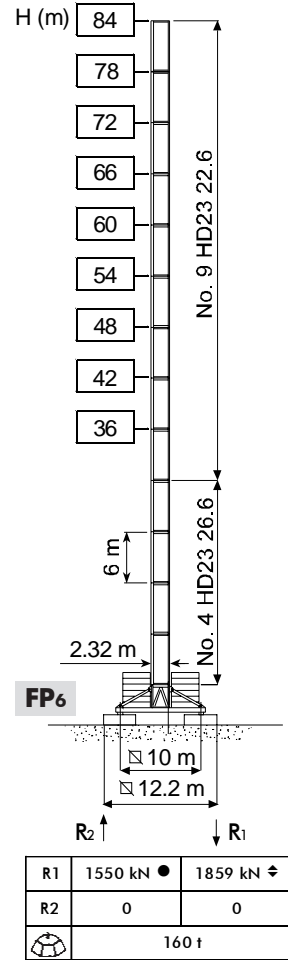
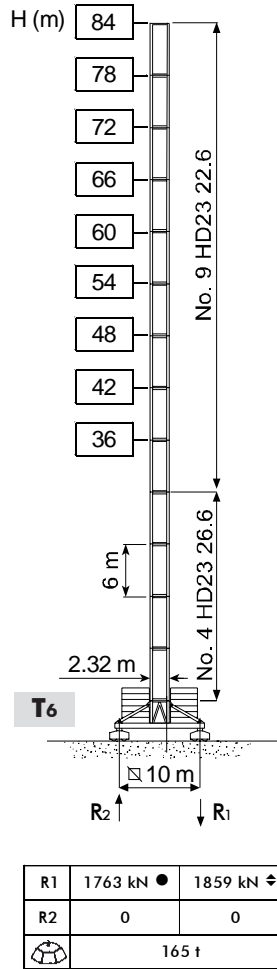
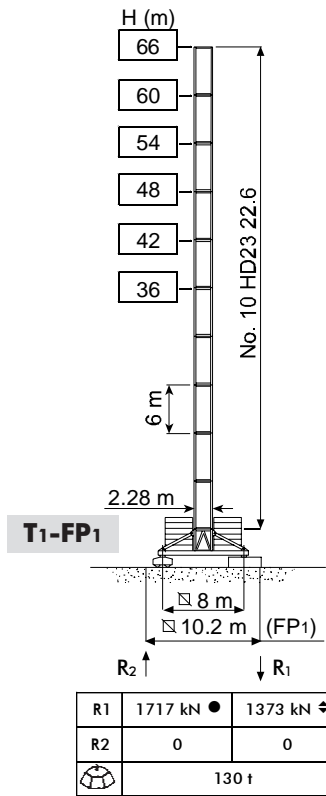

R1	2659 kN ●	4291 kN ◄
R2	1474 kN ●	3236 kN ◄
	187 t	

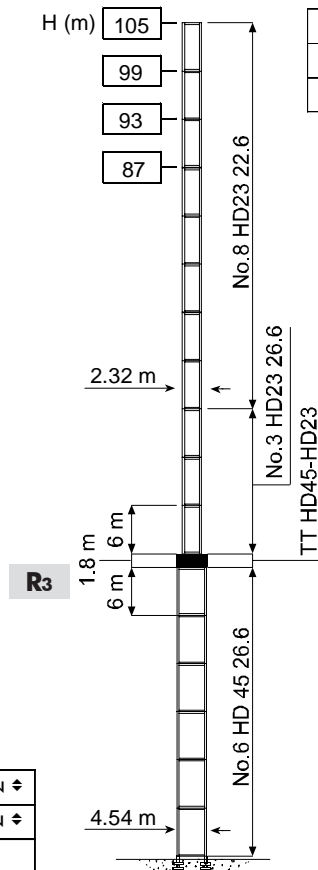
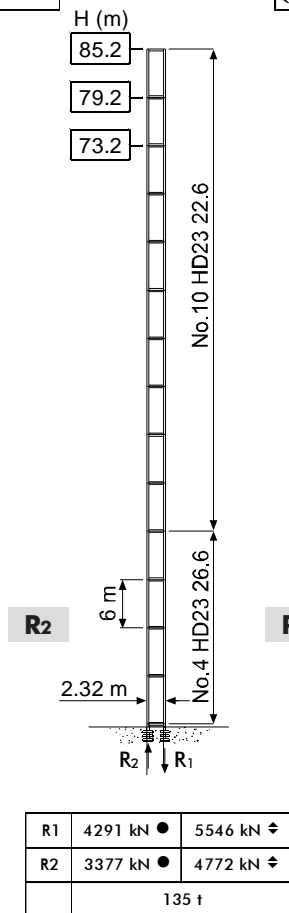
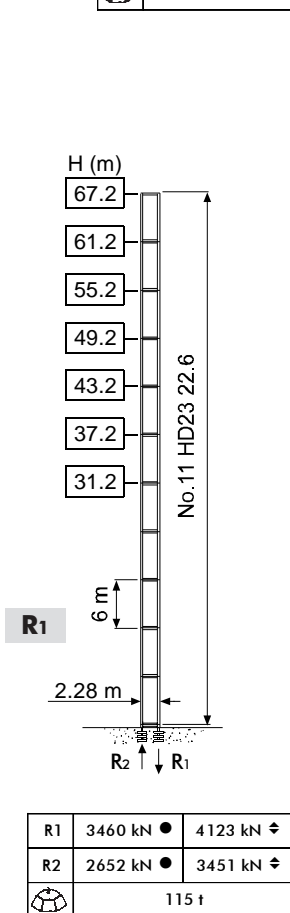

- H Altezza max. sotto gancio (vento max. f.s. 151 km/h)
- In servizio
- ◄ Fuori servizio **I**
- A vuoto, senza zavorra, braccio max., altezza max.
- H Max. under hook height (out-of-service max wind 151 km/h)
- In service
- ◄ Out of service **GB**
- Without load, without ballast, max. jib and max. height
- H Hauteur maxi. sous crochet (vent maxi. h.s. 151 km/h)
- En service
- ◄ Hors service **F**
- A vide, sans lest, avec flèche et hauteur maximum
- H Höchste Hackenhöhe (a.B. max. Wind 151 km/h)
- In Betrieb
- ◄ Außer Betrieb **D**
- Ohne Last und Ballast, mit Maximalausleger und Maximalhöhe
- H Maxima altura bajo gancho (viento máximo f.d.s. 151 km/h)
- En servicio
- ◄ Fuera de servicio **E**
- Sin carga, sin lastre, con pluma y altura máxima

160 * kVA	400 V - 50 Hz / 460 V - 60 Hz	2000/14/CE

* Gru senza traslazione / Crane without travelling equipment / Grue sans translation / Krane ohne Schienenfahren / Grúa sin traslación

		m/min	t	kW	
<p>67 AFC 100 F18 (VECTOR)</p> <p>32.8</p>		0 ⇌ 34	10	67	500 m
		0 ⇌ 41	8		
		0 ⇌ 54	6		
		0 ⇌ 77	4		
		0 ⇌ 118	2.4		
		0 ⇌ 17	20		
		0 ⇌ 20.5	16		
		0 ⇌ 27	12		
		0 ⇌ 38.5	8		
		0 ⇌ 59	4.8		

	DVF 5 11	0 ⇌ 100 m/min	11 kW
	SSR 4 4 80	0.73 r.p.m.	4 × 80 Nm
	TVF 2RG 4M9 D1	0 ⇌ 24 m/min	4 × 9 kW
	TSR 2RG 4M8	12 ⇌ 24 m/min (50 Hz)	4 × 80 Nm
	TSR 4RG 4M8	14 ⇌ 28 m/min (60 Hz)	

	Max. H [m]		
T ₁	47.6	47.6	> 47.6
T ₆	47.6	47.6	> 47.6

	Sollevamento	I	Hoisting	GB	Levage	F	Heben	D	Elevación	E
	Traslazione carrello		Trolleying		Distribution		Katzfahren		Distribución	
	Rotazione		Slewing		Orientation		Schwenken		Orientación	
	Traslazione		Travelling		Translation		Schienenfahren		Traslación	
	Direttiva sul livello acustico		Directive on noise level		Directive sur le niveau acoustique		Richtlinie für den Schall-Leistungspegel		Directiva sobre el nivel acustico	
	Consultateci		Consult us		Nous consulter		Auf Anfrage		Consultarnos	
	Potenza totale richiesta		Power requirements		Puissance totale nécessaire		Geforderte Stromstärke		Potencia necesaria	
	Alimentazione		Power supply		Alimentation		Stromversorgung		Alimentación	

Gru Comedil s.r.l.

A Terex Company



Via S. Egidio 42/A, 33074 Fontanafredda (PN) - Italy
Tel. (+39) 0434 567 311 - Telefax (+39) 0434 998631

Internet e-mail: info@comedil.com
Internet home page: www.comedil.com

Divisione Automontanti

Via Alessandrina, 25 - 20095 Cusano Milanino (MI) - Italy
Tel. (+39) 02 613 16011 - Telefax (+39) 02 613 16034

Internet e-mail: info.CBR@comedil.com