

MC 235 B

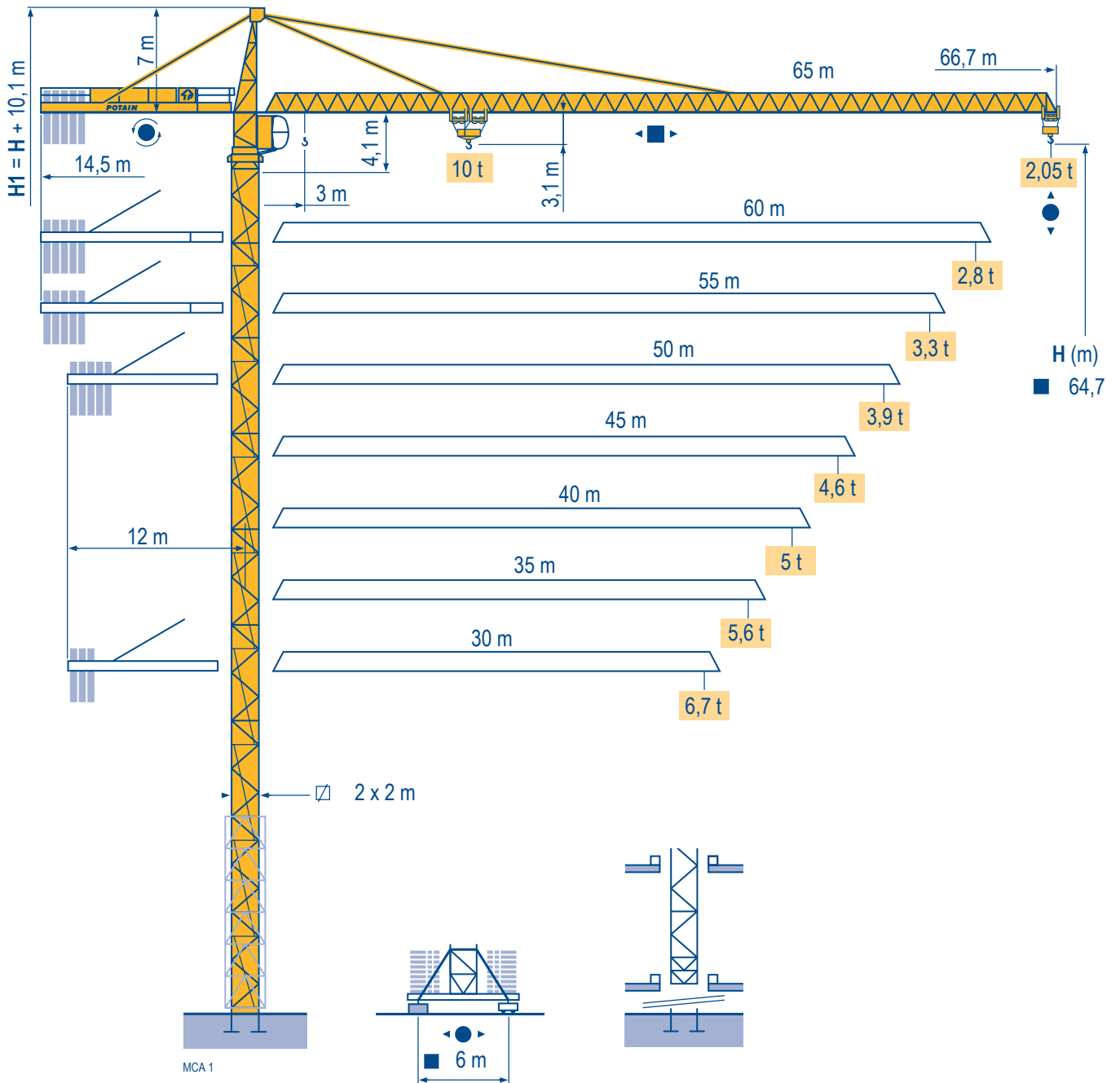

Masts / Reactions

MCA 1

□ 2 m
 ▣ 30 m ⇒ 65 m

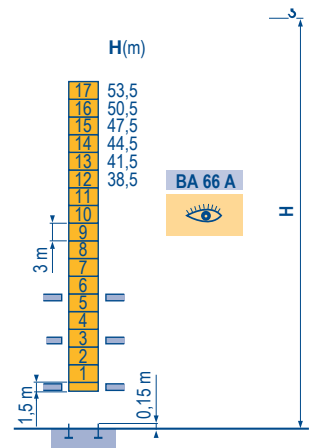
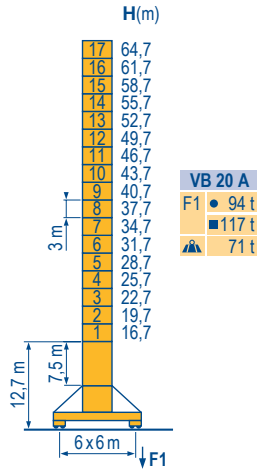
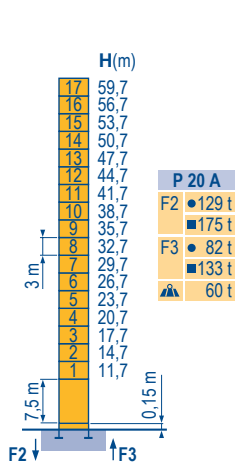

Climbing crane

MCA 1

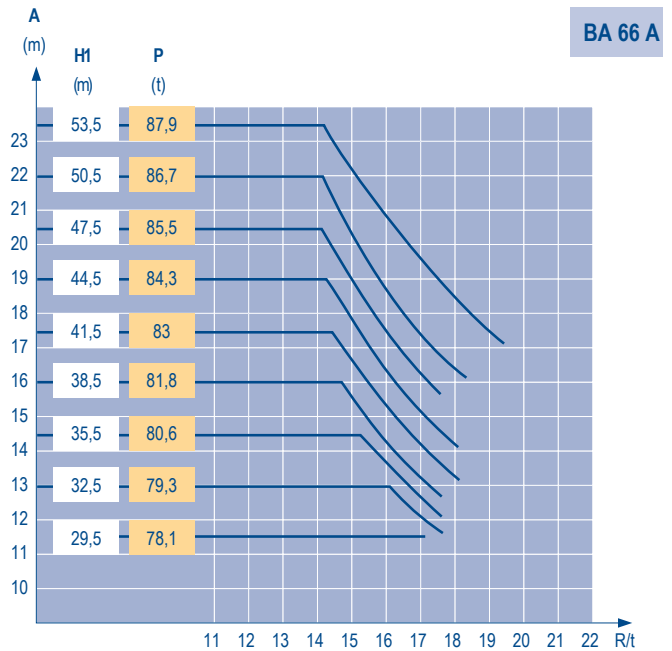
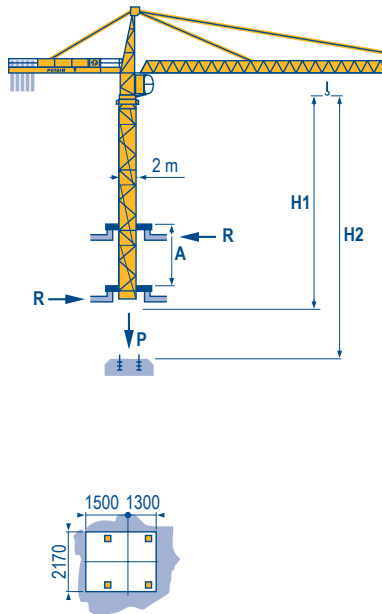

TOPKIT MC 235 B



GB

- Reactions in service
- Reactions out of service
- ▲ Without load, ballast (or transport axles), with maximum jib and maximum height.
- 👁 See climbing crane

Load diagrams

MCA 1

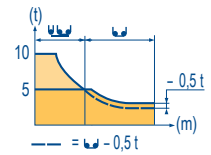
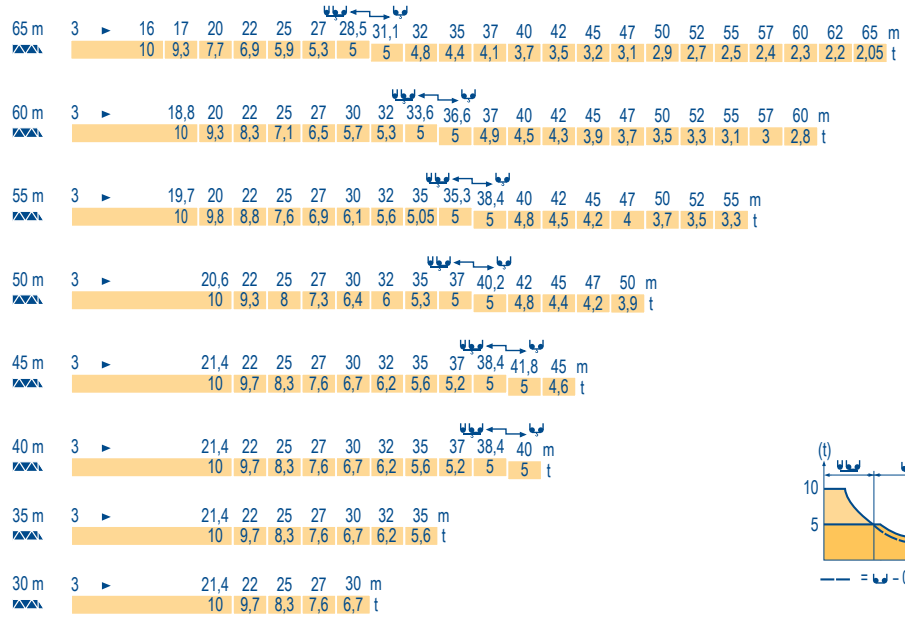

Counter-jib ballast

MCA 1

		4800 kg - 4200 kg 3400 kg
▲	▲	▲ (kg)
65 m	14,5 m	23 600
60 m	14,5 m	21 700
55 m	14,5 m	20 200
50 m	12 m	23 600
45 m	12 m	21 700
40 m	12 m	19 400
35 m	12 m	16 800
30 m	12 m	14 100

Base ballast

MCA 1

☐ 2 m	VB 20 A - ●	H (m)	64,7	61,7	58,7	55,7	52,7	49,7	46,7	43,7	40,7	37,7	34,7	31,7	28,7	25,7	22,7	19,7	16,7	13,7
▲ (t)			108	84	72	60	48	36	36	36	36	36	36	36	36	36	36	36	36	36

Anchorage

MCA 1

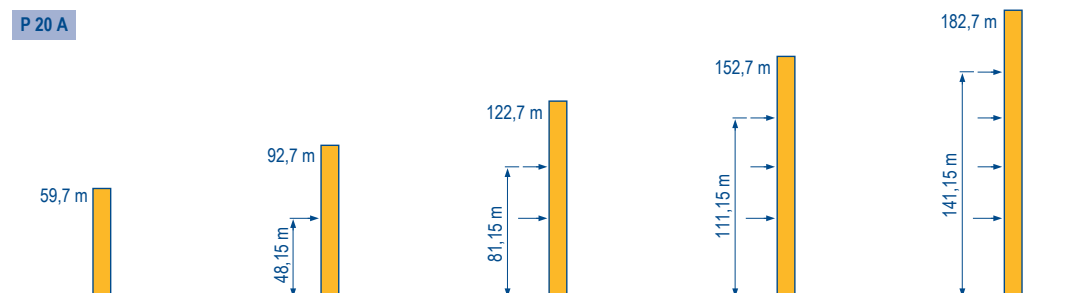

TOPKIT MC 235 B

POTAIN

GB

- A Distance between collars
- H1 Crane height
- P Crane weight (in service)
- R Horizontal reaction

Mechanisms

MCA 2

													hp	kW			
	50 LVF 25 Optima	m/min	3 → 12 → 36 → 46 → 66 → 96					1,5 → 6 → 18 → 23 → 33 → 48					50	37	557 m		
		t	5	5	5	3,75	25	1,25	10	10	10	7,5				5	2,5
	6 D3 V4	m/min	10 - 50 (10 t) - 100 (5t)										6	4,4			
	RCV 185	rpm	0 → 0,8										2 x 9	2 x 6,6			
	VB 20 A RT 544 A1 2V R ≥ 13 m	m/min	13,5 → 27										4 x 7	4 x 5,2			
CEI 38						IEC 38						kVA					
400 V (+6% -10%) 50 Hz												50 LVF : 75kVA					

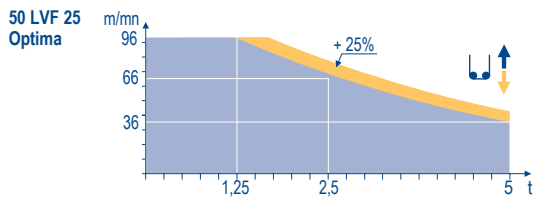

GB

- Hoisting
- Trolleying
- Slewing
- Travelling



This commercial document is not legally binding.
For any technical information, please refer to the corresponding instructions.

Manitowoc
Crane CARE

Manitowoc
Crane Group



Americas
Tel : +1 888 479 7278
Tel : +1 717 593 2000

Europe - Middle East - Africa
Tel : +33 (0) 4 72 81 50 00
Tel : +44 (0) 191 522 2000

Asia - Pacific
Tel : +65 6264 1188
Fax : +65 6862 4040

www.manitowoccrane.com

Manitowoc Crane Group Asia Pte Ltd
Manitowoc Crane Group
4 Kwong Min Road
Singapore 628707
Tel: +65 6264 1188
Fax: +65 6862 4040
www.manitowoccrane.com

MC 235 B
Réf. 2004 45 MCA 4

Copyright.Reproduction interdite © POTAIN 2004

Réalisation Secdoc